



# Electromechanical Relay Contact Output Module

Cat. No. 1771-OW16 Series B

## Inside...

To:	See Page:
Important User Information	1
Preinstallation Considerations	5
Calculate Power Requirements	6
Key the Backplane Connector	7
Install the Module and Field Wiring Arm	7
Connect Wiring to the Field Wiring Arm	8
Interpret the Status Indicators	11
Specifications	12
Rockwell Automation Support	BackCover

## Important User Information





Solid state equipment has operational characteristics differing from those of electromechanical equipment. Safety Guidelines for the Application, Installation and Maintenance of Solid State Controls (Publication SGI-1.1 available from your local Rockwell Automation sales office or online at <http://www.rockwellautomation.com/literature>) describes some important differences between solid state equipment and hard-wired electromechanical devices. Because of this difference, and also because of the wide variety of uses for solid state equipment, all persons responsible for applying this equipment must satisfy themselves that each intended application of this equipment is acceptable.

In no event will Rockwell Automation, Inc. be responsible or liable for indirect or consequential damages resulting from the use or application of this equipment.

The examples and diagrams in this manual are included solely for illustrative purposes. Because of the many variables and requirements associated with any particular installation, Rockwell Automation, Inc. cannot assume responsibility or liability for actual use based on the examples and diagrams. No patent liability is assumed by Rockwell Automation, Inc. with respect to use of information, circuits, equipment, or software described in this manual. Reproduction of the contents of this manual, in whole or in part, without written permission of Rockwell Automation, Inc., is prohibited.

Throughout this manual we use notes to make you aware of safety considerations.

---

<b>WARNING</b> 	Identifies information about practices or circumstances that can cause an explosion in a hazardous environment, which may lead to personal injury or death, property damage, or economic loss.
<b>ATTENTION</b> 	Identifies information about practices or circumstances that can lead to personal injury or death, property damage, or economic loss. Attentions help you: <ul style="list-style-type: none"><li>• identify a hazard</li><li>• avoid a hazard</li><li>• recognize the consequence</li></ul>
<b>IMPORTANT</b>	Identifies information that is critical for successful application and understanding of the product.
<b>SHOCK HAZARD</b> 	Labels may be located on or inside the equipment (e.g., drive or motor) to alert people that dangerous voltage may be present.
<b>BURN HAZARD</b> 	Labels may be located on or inside the equipment (e.g., drive or motor) to alert people that surfaces may be dangerous temperatures.

---

**ATTENTION****Environment and Enclosure**

This equipment is intended for use in a Pollution Degree 2 industrial environment, in overvoltage Category II applications (as defined in IEC publication 60664-1), at altitudes up to 2000 meters without derating.

This equipment is considered Group 1, Class A industrial equipment according to IEC/CISPR Publication 11. Without appropriate precautions, there may be potential difficulties ensuring electromagnetic compatibility in other environments due to conducted as well as radiated disturbance.

This equipment is supplied as “open type” equipment. It must be mounted within an enclosure that is suitably designed for those specific environmental conditions that will be present and appropriately designed to prevent personal injury resulting from accessibility to live parts. The interior of the enclosure must be accessible only by the use of a tool. Subsequent sections of this publication may contain additional information regarding specific enclosure type ratings that are required to comply with certain product safety certifications.

See NEMA Standards publication 250 and IEC publication 60529, as applicable, for explanations of the degrees of protection provided by different types of enclosure. Also, see the appropriate sections in this publication, as well as the Allen-Bradley publication 1770-4.1 (Industrial Automation Wiring and Grounding Guidelines), for additional installation requirements pertaining to this equipment.

**ATTENTION****Preventing Electrostatic Discharge**

This equipment is sensitive to electrostatic discharge, which can cause internal damage and affect normal operation.



Follow these guidelines when you handle this equipment:

- Touch a grounded object to discharge potential static.
- Wear an approved grounding wriststrap.
- Do not touch connectors or pins on component boards.
- Do not touch circuit components inside the equipment.
- If available, use a static-safe workstation.
- When not in use, store the equipment in appropriate static-safe packaging.

**WARNING**  When you connect or disconnect the wiring arm with field side power applied, an electrical arc can occur. This could cause an explosion in hazardous location installations. Be sure that power is removed or the area is nonhazardous before proceeding.

**WARNING**  If you connect or disconnect wiring while field side power is applied, an electrical arc can occur. This could cause an explosion in hazardous location installations. Be sure that power is removed or the area is nonhazardous before proceeding.

**North American Hazardous Location Approval**

<b>The following information applies when operating this equipment in hazardous locations:</b>	<b>Informations sur l'utilisation de cet équipement en environnements dangereux :</b>	
<p>Products marked "CL I, DIV 2, GP A, B, C, D" are suitable for use in Class I Division 2 Groups A, B, C, D, Hazardous Locations and nonhazardous locations only. Each product is supplied with markings on the rating nameplate indicating the hazardous location temperature code. When combining products within a system, the most adverse temperature code (lowest "T" number) may be used to help determine the overall temperature code of the system. Combinations of equipment in your system are subject to investigation by the local Authority Having Jurisdiction at the time of installation.</p>	<p>Les produits marqués "CL I, DIV 2, GP A, B, C, D" ne conviennent qu'à une utilisation en environnements de Classe I Division 2 Groupes A, B, C, D dangereux et non dangereux. Chaque produit est livré avec des marquages sur sa plaque d'identification qui indiquent le code de température pour les environnements dangereux. Lorsque plusieurs produits sont combinés dans un système, le code de température le plus défavorable (code de température le plus faible) peut être utilisé pour déterminer le code de température global du système. Les combinaisons d'équipements dans le système sont sujettes à inspection par les autorités locales qualifiées au moment de l'installation.</p>	
<p><b>WARNING</b> </p>	<p><b>EXPLOSION HAZARD</b></p> <ul style="list-style-type: none"> <li>• Do not disconnect equipment unless power has been removed or the area is known to be nonhazardous.</li> <li>• Do not disconnect connections to this equipment unless power has been removed or the area is known to be nonhazardous. Secure any external connections that mate to this equipment by using screws, sliding latches, threaded connectors, or other means provided with this product.</li> <li>• Substitution of components may impair suitability for Class I, Division 2.</li> <li>• If this product contains batteries, they must only be changed in an area known to be nonhazardous.</li> </ul>	<p><b>AVERTISSEMENT</b> </p> <p><b>RISQUE D'EXPLOSION</b></p> <ul style="list-style-type: none"> <li>• Couper le courant ou s'assurer que l'environnement est classé non dangereux avant de débrancher l'équipement.</li> <li>• Couper le courant ou s'assurer que l'environnement est classé non dangereux avant de débrancher les connecteurs. Fixer tous les connecteurs externes reliés à cet équipement à l'aide de vis, loquets coulissants, connecteurs filetés ou autres moyens fournis avec ce produit.</li> <li>• La substitution de composants peut rendre cet équipement inadapté à une utilisation en environnement de Classe I, Division 2.</li> <li>• S'assurer que l'environnement est classé non dangereux avant de changer les piles.</li> </ul>

## Preinstallation Considerations

This module must be used with a 1771-A1B through 1771-A4B or later chassis. It may also be used in a 1771-AM1 or 1771-AM2 chassis. This module does not contain surge limiting circuitry. With properly chosen surge limiting devices, this module can be used to control resistive, capacitive, and inductive loads.

The module's outputs are arranged in two groups of eight, each output is independently isolated. The first group of outputs are arranged as normally-open contacts, and the second group of outputs are arranged as selectable normally-open or normally-closed contacts.

Refer to Specifications on page 12 for complete output specifications. Relay

## Reliability

Varying load conditions can drastically shorten relay life. Operation at the same load conditions, preferably at low loads, delivers long relay life. Do not operate relays at low current or voltage after operating them at high power conditions. Operations at low power first, followed by high power, is acceptable.

## Relay Environment

Relays in this module are not hermetically sealed. Do not use this module in environments with contaminants such as acid, ammonia, nitrogen, and chlorine.

## Module Loading

Both minimum current and minimum voltage specifications are given to assure there is always a good conduction surface between the relay's contacts. The relays will function at less than minimum specified voltages and currents, but module reliability is not guaranteed.

Exceeding the module's maximum power ratings will shorten the life of the relay contacts. Do not operate this module with voltage, current, or power levels higher than the maximum specifications, as given in the Specifications section of this installation instruction.

## Load Characteristics

Inductive or high current loads cause arcing of the relay contacts, resulting in shortened contact life. Use a resistor-capacitor network (RC) across the contacts to suppress arcing. Failure to use an RC filter network could result in generation of electromagnetic noise (EMI) which can disrupt nearby electrical equipment, including your 1771 I/O chassis. Connect the RC filter across the contacts at the field wiring arm connections. If this is not possible, an alternate (but not as effective) solution would be to place the RC network across the load.

**ATTENTION**



Wirewound resistors do have some inductance associated with them and may require an RC Filter network.

### Allen-Bradley Suppressors

Allen-Bradley Equipment	Suppressor Catalog Number
Motor Starter Bulletin 509	599-KD4
Motor Starter Bulletin 709	1401-N10 <sup>1</sup>
Relay Bulletin 700 Type N or P	700N5/700N9
Miscellaneous	700-N24 <sup>2</sup>

<sup>1</sup> For starters with 120V ac coils.

<sup>2</sup> Bulletin 700-N24 is a universal surge suppressor. You can use it on electromagnetic devices with the limitation of 35 sealed VA, 150V.

## Calculate Power Requirements

The module receives its power through the 1771 I/O chassis backplane from the chassis power supply. This supply also provides the necessary power to energize the coils of the module's relays. The maximum current required from this supply with all coils energized is 1.3 A.

Add this current to the requirements of all other modules in the I/O chassis to prevent overloading the chassis backplane and/or backplane power supply.

## Key the Backplane Connector

Place your module in any slot in the chassis except the leftmost slot which is reserved for processors or adapters.

**ATTENTION**



Observe the following precautions when inserting or removing keys:

- insert or remove keys with your fingers
- make sure that key placement is correct

Incorrect keying or the use of a tool can result in damage to the backplane connector and possible system faults.

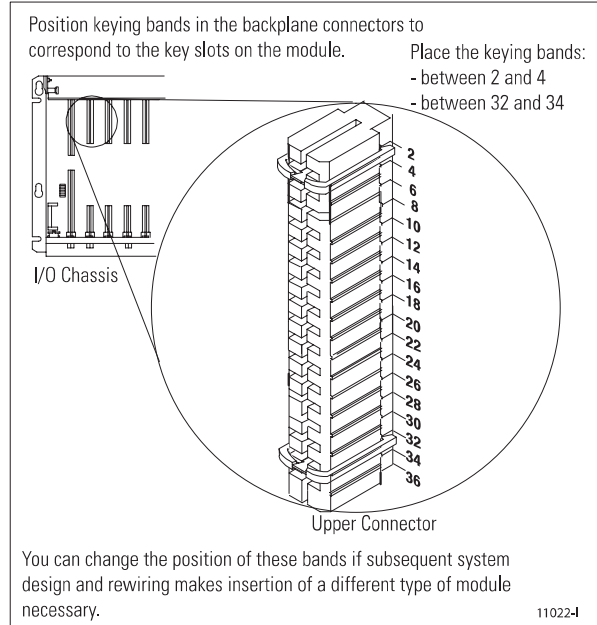

## Install the Module and Field Wiring Arm

**WARNING**



If you connect or disconnect wiring while field-side power is on, an electrical arc can occur. This could cause an explosion in hazardous locations. Be sure that power is removed or the area is nonhazardous before proceeding.

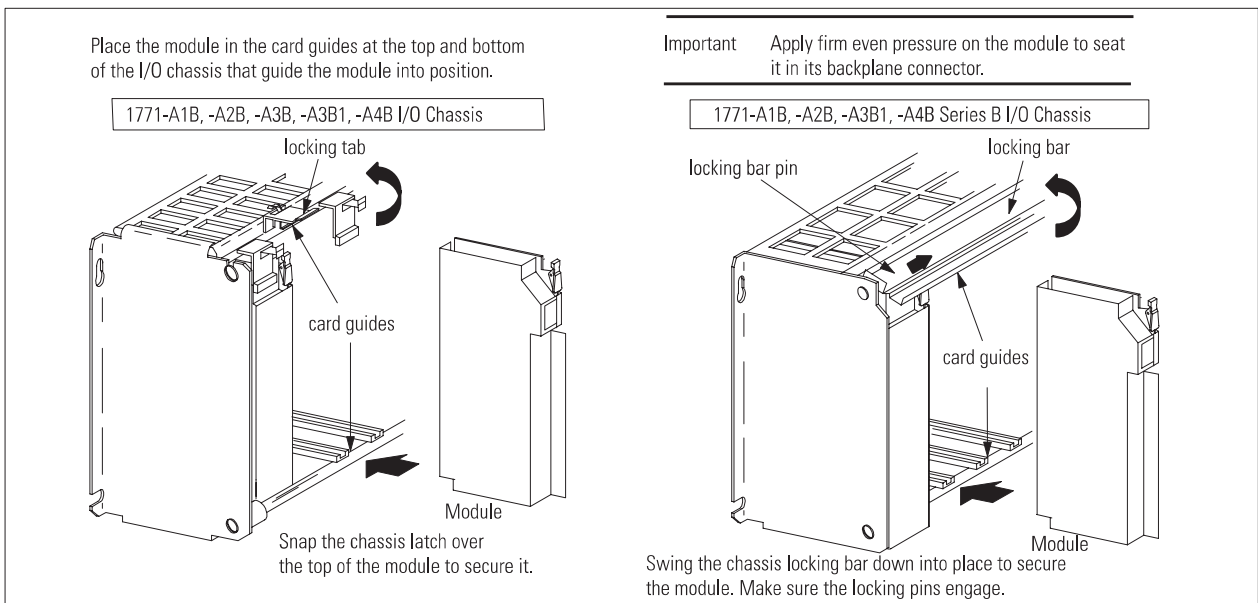

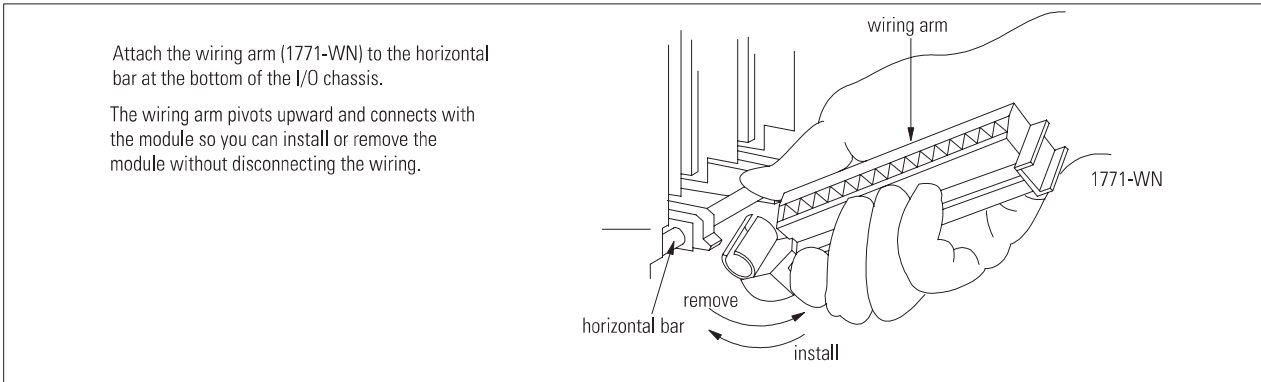

The 1771-OW16 module is a modular component of the 1771 I/O system requiring a properly installed system chassis. Refer to publication 1771-IN075 for detailed information on acceptable chassis, proper installation, and grounding requirements. Limit the maximum adjacent slot power dissipation to 10W maximum, or derate the module in accordance with the derating curve in the specifications section of this installation instruction.

## Connect Wiring to the Field Wiring Arm

Make wiring connections to the module through the field wiring arm (cat. no. 1771-WN). The arm pivots on the I/O chassis to connect with terminals on the front of the module and acts as a terminal strip. The wiring arm allows the module to be removed from the chassis without disconnecting the wiring.

---

**WARNING**



When you connect or disconnect the wiring arm with field side power applied, an electrical arc can occur. This could cause an explosion in hazardous location installations. Be sure that power is removed or the area is nonhazardous before proceeding.

---

**WARNING**



If you connect or disconnect wiring while field side power is applied, an electrical arc can occur. This could cause an explosion in hazardous location installations. Be sure that power is removed or the area is nonhazardous before proceeding.

- 
1. Make certain all power is removed from the module before making wiring connections.
  2. Swing the wiring arm up into position on the front of the module. The locking tab on the module will secure it into place.



**IMPORTANT** The field wiring arm terminal identification number is not the same as the number of the bit which controls that output

For operating voltages in excess of 125V, use the same phase to maintain channel-to-channel isolation.

**Connection Diagram for the 1771-OW16 Contact Output Module**

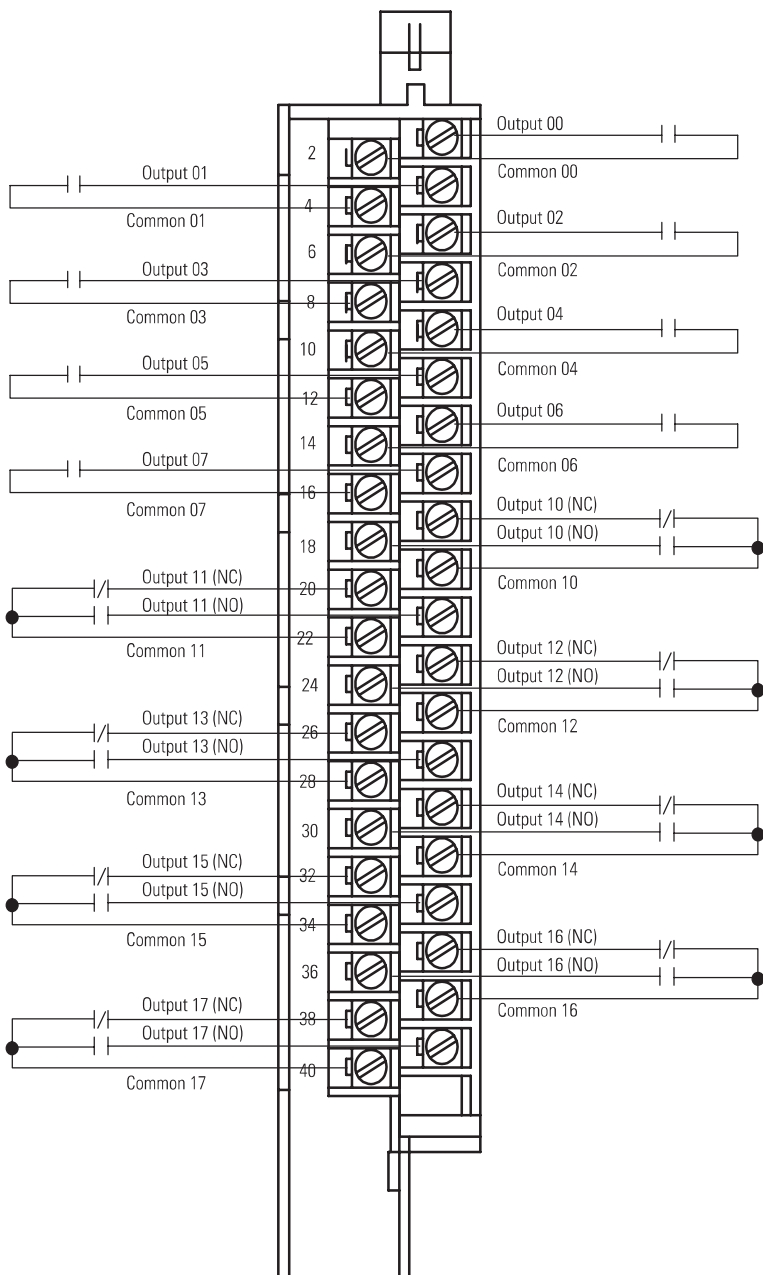

Terminal	Function
1	Output 00 (NO)
2	Common for output 00
3	Output 01 (NO)
4	Common for output 00
5	Output 01 (NO)
6	Common for output 00
7	Output 03 (NO)
8	Common for output 00
9	Output 04 (NO)
10	Common for output 00
11	Output 05 (NO)
12	Common for output 00
13	Output 06 (NO)
14	Common for output 00
15	Output 07 (NO)
16	Common for output 00
17	Output 10 (NC)
18	Output 10 (NO)
19	Common for output 00
20	Output 11 (NC)
21	Output 11 (NO)
22	Common for output 00
23	Output 12 (NC)
24	Output 12 (NO)
25	Common for output 00
26	Output 13 (NC)
27	Output 13 (NO)
28	Common for output 00
29	Output 14 (NC)
30	Output 14 (NO)
31	Common for output 00
32	Output 15 (NC)
33	Output 15 (NO)
34	Common for output 00
35	Output 16 (NC)
36	Output 16 (NO)
37	Common for output 00
38	Output 17 (NC)
39	Output 17 (NO)
40	Common for output 00

You can use an output of the 1771-OW16 series B module to drive an input of a 1771-ac/dc input module (1771-IAD series B) to indicate the status of turning on a motor starter, for example (see the following figure). Inputs configured with the output module are not isolated from each other.

**ATTENTION** Do not attempt to increase load current or wattage capability beyond the maximum rating by connecting two or more outputs in parallel. The slightest variation in relay switching time may cause one relay to momentarily switch the total load current.

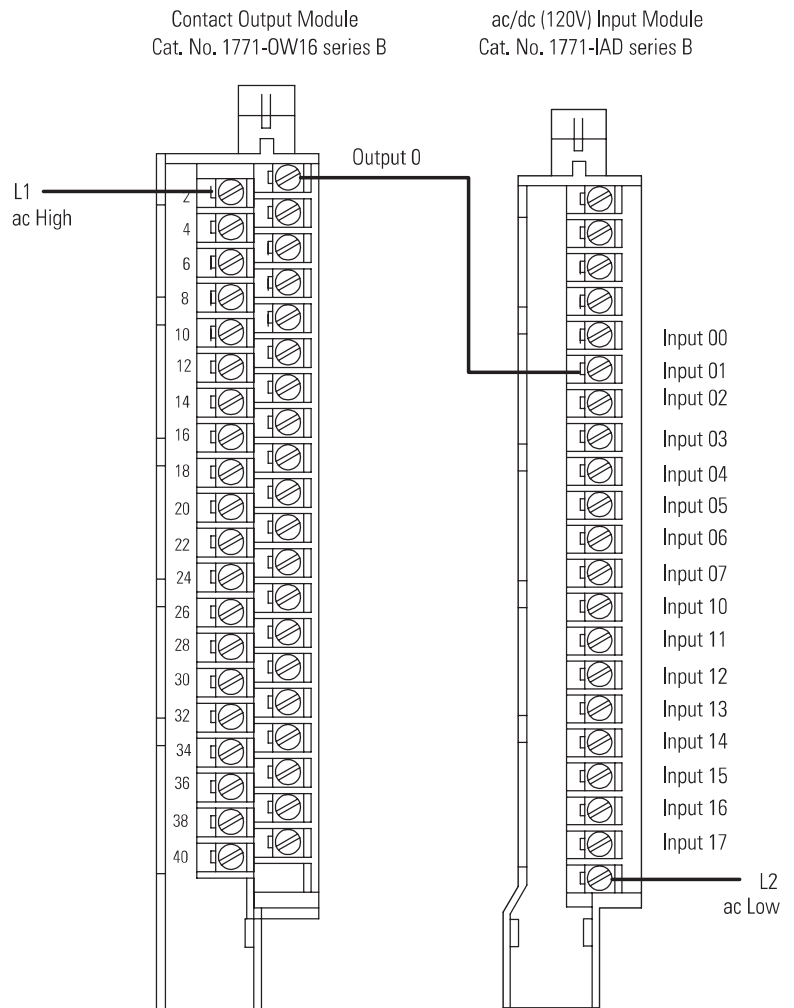

## Interpret the Status Indicators

The module has 16 output status indicators (see below). Each indicator represents the system side control status of the corresponding output relay. Each indicator is on when its corresponding relay is energized.

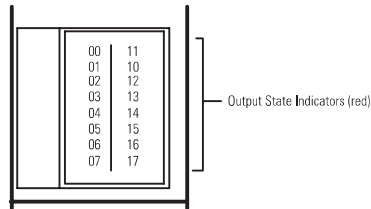

## Specifications

Specifications		ac/dc (240V ac/150V dc) Electromechanical Relay Contact Output Module (cat. no. 1771-OW16)
Number of Outputs		16
Module Location		1771-I/O Chassis, 1 slot
Voltage Rating		240V ac @ 47-63 Hz; 150V dc - Refer to page 14
Current Rating		Refer to Table 2 on page 14
Maximum surge current		dc: 2 A max per output (at rated power) ac: Refer to Table 3 on page 14
Minimum Contact Load <sup>1</sup>		10 mA
Operate/Release Time		10 ms maximum; 5 ms ( $\pm 1$ ms)
Switching Frequency		1/3 Hz at maximum load
Bounce Time		4.0 ms maximum
Expected Life of Electrical Contacts		300 K operations @ 25 °C (cos $\theta = 1$ )
Backplane Current		1.3 A maximum
Power Dissipation		All relays on: 6.5 Watts
Thermal Dissipation		All relays on: 22.24 BTU/hr
Isolation Voltage (continuous-voltage withstand rating)		250V basic system to user side 125V basic between channels Tested to 1500 V ac for 60 s
Fusing		Fusing of outputs is recommended. Use 3.0 A, 250V ac slow-blow fuses (Littelfuse pt. no. 239003).
External Over-current Protection		15 A branch circuit protection
Indicators		8 yellow status indicators - show status of individual outputs. If relay output bit is on, corresponding output indicator is on.
Environmental Conditions		
Operating Temperature		IEC 60068-2-1 (Test Ad, Operating Cold), IEC 60068-2-2 (Test Bd, Operating Dry Heat), IEC 60068-2-14 (Test Nb, Operating Thermal Shock): 0 to 60 °C (32 to 140 °F)
Storage Temperature		IEC 60068-2-1 (Test Ab, Unpackaged Nonoperating Cold), IEC 60068-2-2 (Test Bb, Unpackaged Nonoperating Dry Heat), IEC 60068-2-14 (Test Na, Unpackaged Nonoperating Thermal Shock): -40 to 85 °C (-40 to 185 °F)
Relative Humidity		IEC 60068-2-30 (Test Db, Unpackaged nonoperating Damp Heat): 5 to 95% noncondensing
Vibration		IEC 60068-2-6 (Test Fc, Operating): 2g @ 10...500 Hz
Shock	Operating Nonoperating	IEC 60068-2-27 (Test Ea, Unpackaged Shock): 30g 50g
ESD Immunity		IEC 61000-4-2: 6 kV indirect contact discharges
Radiated RF Immunity		IEC 61000-4-3: 10 V/m with 1kHz sine-wave 80%AM from 30 MHz to 1000 MHz
EFT/B Immunity		IEC 61000-4-4: $\pm 1$ kV at 5 kHz on signal ports
Surge Transient Immunity		IEC 61000-4-5: $\pm 1$ kV line-line(DM) and $\pm 2$ kV line-earth(CM) on signal ports
Conducted RF Immunity		IEC 61000-4-6: 10 Vrms with 1 kHz sine-wave 80%AM from 150 kHz to 30 MHz
Emissions		CISPR 11: Group 1, Class A (with appropriate enclosure)
Enclosure Type Rating		None (open-style)
Conductors	Wire Size Category <sup>2</sup>	0.34...2.5 mm <sup>2</sup> (22...14 AWG) stranded copper wire rated at 75 °C or higher 1.2 mm (3/64 inch) insulation maximum 2 - on signal ports
Field Wiring Arm		Catalog Number 1771-WN
Field Wiring Arm Screw Torque		1.0 Nm (9 pound-inches)

Keying	between 2 and 4 between 32 and 34
Certifications (when product is marked) <sup>3</sup>	<p><b>UL</b> UL Listed Industrial Control Equipment</p> <p><b>CSA</b> CSA certified Process Control Equipment</p> <p><b>CSA</b> CSA certified Process Control Equipment for Class I, Division 2, Groups A, B, C and D Hazardous Locations</p> <p><b>CE</b> European Union 89/336/EEC EMC Directive, compliant with: EN 61000-6-4; Industrial Emissions EN 50082-2; Industrial Immunity EN 61326; Meas./Control/Lab., Industrial Requirements EN 61000-6-2; Industrial Immunity</p> <p><b>CE</b> European Union 73/23/EEC LVD Directive, compliant with: 61131-2 - Programmable Controllers</p> <p><b>C-Tick</b> Australian Radiocommunications Act compliant with AS/NZS CISPR 11, Industrial Emissions</p>
<p>1 Minimum switching loads mentioned above are reference values. Please perform the confirmation test with the actual load before production since reference values may vary according to switching frequencies, environmental conditions and expected reliability levels</p> <p>2 You use this category information for planning conductor routing as described in Allen-Bradley publication 1770-4.1, Industrial Automation Wiring and Grounding Guidelines.</p> <p>3 For the latest up-to-date information, see the Product Certification link at <a href="http://www.ab.com">www.ab.com</a> for Declarations of Conformity, Certificates and other certification details.</p>	

**Figure 1 Maximum Switching Power**

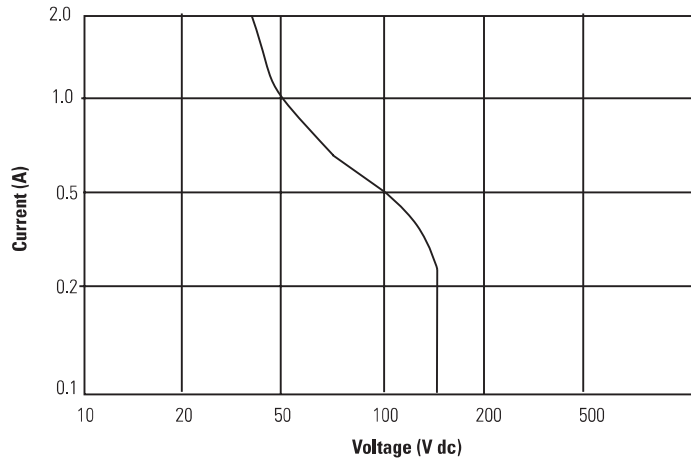

**Table 1 UL and CSA Ratings**

Amperes	Voltage
2	250V ac, resistive
2	30V dc, resistive
2	250V ac, 50/60 Hz, 360 VA

Note: All ac voltages must be the same phase.

**Table 2 Manufacturer Ratings - Resistive**

	ac	dc
Maximum Switching Power	500 VA	See Figure 1, Switching Power
Maximum Switching Voltage	250 VA	150V
Maximum Switching Current	2 A	2 A
Module Maximum Switching Power	1440 VA	1280 W

**Table 3 Maximum ac Surge Current**

Maximum Contact Rating					
ac Voltage	Amperes		Continuous Carrying Current	Maximum Voltamperes	
	Make	Break		Make	Break
120	30	3	2	3600	360
240	15	1.5	2	3600	360

**ATTENTION**

Any use of this module outside the listed ratings is not allowed in applications requiring a listed system.



Figure 2 Derating Curve

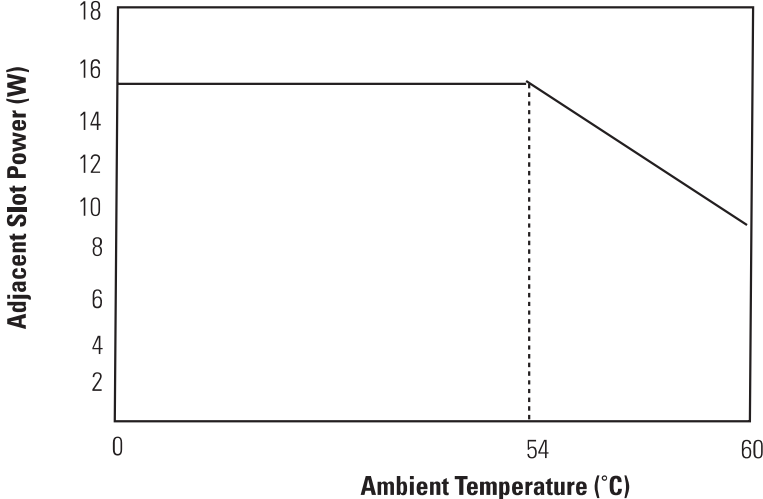

## Rockwell Automation Support

Rockwell Automation provides technical information on the web to assist you in using our products. At <http://support.rockwellautomation.com>, you can find technical manuals, a knowledge base of FAQs, technical and application notes, sample code and links to software service packs, and a MySupport feature that you can customize to make the best use of these tools.

For an additional level of technical phone support for installation, configuration and troubleshooting, we offer TechConnect Support programs. For more information, contact your local distributor or Rockwell Automation representative, or visit <http://support.rockwellautomation.com>.

## Installation Assistance

If you experience a problem with a hardware module within the first 24 hours of installation, please review the information that's contained in this manual. You can also contact a special Customer Support number for initial help in getting your module up and running:

United States	1.440.646.3223 Monday – Friday, 8am – 5pm EST
Outside United States	Please contact your local Rockwell Automation representative for any technical support issues.

## New Product Satisfaction Return

Rockwell tests all of our products to ensure that they are fully operational when shipped from the manufacturing facility. However, if your product is not functioning and needs to be returned:

United States	Contact your distributor. You must provide a Customer Support case number (see phone number above to obtain one) to your distributor in order to complete the return process.
Outside United States	Please contact your local Rockwell Automation representative for return procedure.

**[www.rockwellautomation.com](http://www.rockwellautomation.com)**

### Power, Control and Information Solutions Headquarters

Americas: Rockwell Automation, 1201 South Second Street, Milwaukee, WI 53204-2496 USA, Tel: (1) 414.382.2000, Fax: (1) 414.382.4444

Europe/Middle East/Africa: Rockwell Automation, Vorstlaan/Boulevard du Souverain 36, 1170 Brussels, Belgium, Tel: (32) 2 663 0600, Fax: (32) 2 663 0640

Asia Pacific: Rockwell Automation, Level 14, Core F, Cyberport 3, 100 Cyberport Road, Hong Kong, Tel: (852) 2887 4788, Fax: (852) 2508 1846

Publication 1771-IN069B-EN-P - November 2005

Supersedes Publication 1771-5.69 - January 1999

PN 957974-53

Copyright © 2005 Rockwell Automation, Inc. All rights reserved. Printed in the U.S.A.