

Power supply CP-D 24/4.2

Primary switch mode power supply

Data sheet

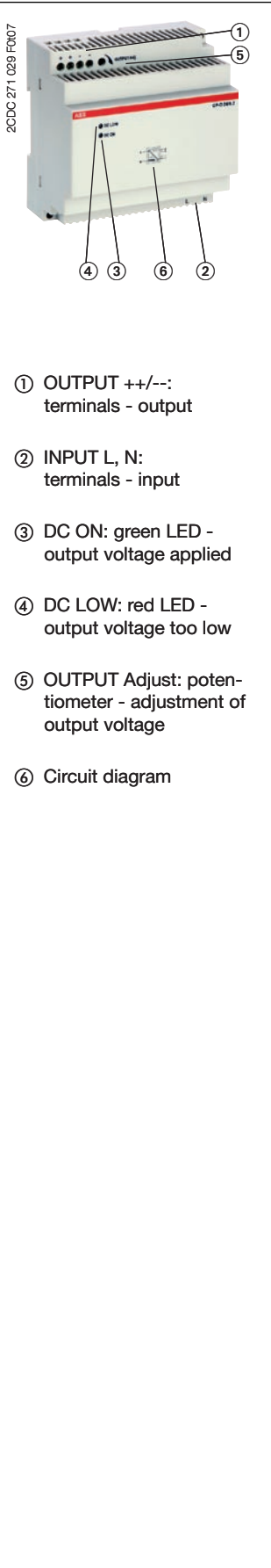

- ① OUTPUT ++/--: terminals - output
- ② INPUT L, N: terminals - input
- ③ DC ON: green LED - output voltage applied
- ④ DC LOW: red LED - output voltage too low
- ⑤ OUTPUT Adjust: potentiometer - adjustment of output voltage
- ⑥ Circuit diagram

Features

- Rated output voltage 24 V DC
- Output voltage adjustable via front-face potentiometer "OUTPUT Adjust"
- Rated output current 4.2 A
- Rated output power 100 W
- Wide range input 100-240 V AC (90-264 V AC, 120-370 V DC)
- Efficiency of typ. 89 %
- Low power dissipation and low heating
- Free convection cooling (no forced cooling with ventilators)
- Ambient temperature range during operation -25...+70 °C
- Open-circuit, overload and short-circuit stable
- Integrated input fuse
- U/I characteristic (fold-forward behaviour at overload - no switch-off)
- LEDs for status indication
- Structural form ideal for installation in distribution panels
- Light-grey enclosure in RAL 7035

Approvals

- UL 508, CAN/CSA C22.2 No.14 *)
 - UL 60950, CAN/CSA C22.2 No.60950 *)
 - GOST
 - CCC *)
- *) Approval refers to rated input voltage U_{IN}

Marks

- CE CE
- C-Tick pending

Order data

Type	Rated input voltage	Rated output voltage / current	Order code
CP-D 24/4.2	100-240 V AC	24 V DC / 4.2 A	1SVR 427 045 R0400

Application

The primary switch mode power supply has two voltage input ranges. This enables the supply with AC or DC. Furthermore it is equipped with two generous capacitors, which ensure mains buffering of at least 60 ms. That is why the device can be used worldwide also in high fluctuating networks and battery-powered plants.

Operating mode

Adjustable output voltage

This device features an continuously adjustable output voltage from 24-28 V DC. Thus they can be optimally adapted to the application, e.g. compensating the voltage drop caused by a long line length.

Power supply CP-D 24/4.2

Primary switch mode power supply

Data sheet

Installation

Mounting

The switch mode power supply can be snapped on a DIN rail according to EN 60715 as shown in the accompanying picture. For that the device is set with its mounting rail slide on the upper edge of the mounting rail and locked by lifting it downwards.

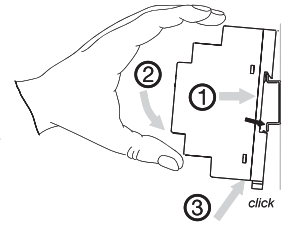

2000 272 041 F06/07

Demounting

Remove the switch mode power supply as shown in the accompanying picture. For that the latching lever is pulled downwards by means of the screwdriver. Alternatively you can press the unlock button to release the device. Then in both cases the device can be unhinged from the mounting rail edge and removed.

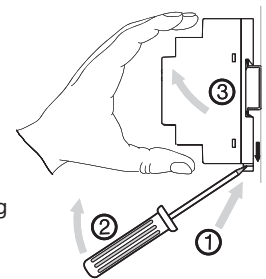

2000 272 041 F06/07

Mounting position

The devices have to be mounted horizontally with the input terminals on the bottom. In order to ensure a sufficient convection, the minimum distance to other modules should not be less than 25 mm in vertical direction and horizontal direction.

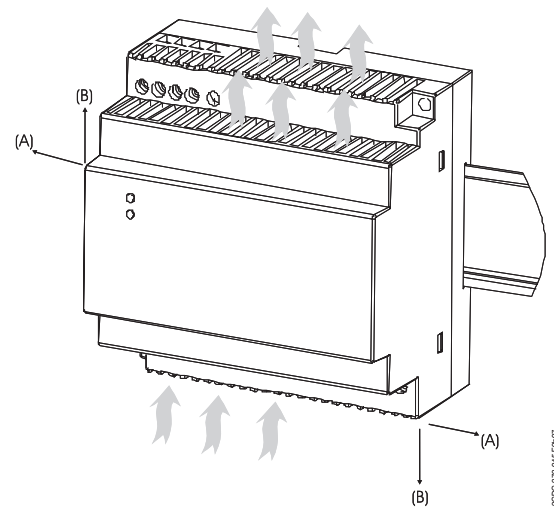

2000 272 041 F06/07

Electrical connection

Connect the input terminals L and N. The installation must be executed acc. to EN 60950, provide a suitable disconnecting device (e. g. line protection switch) in the supply line. The input side is protected by an internal input fuse.

Rate the lines for the maximum output current or provide a separate fuse protection. We recommend to choose the cable section as large as possible in order to minimize voltage drops. Observe the polarity. Actuate plug connector only when power is off. The device is overload, short-circuit and open-circuit proof. The secondary side of the power supply is electrically isolated from the input and internally not earthed (SELV) and can therefore be earthed by the user according to the needs with + or - (PELV).

Power supply CP-D 24/4.2

Primary switch mode power supply

Data sheet

Connection diagram(s)

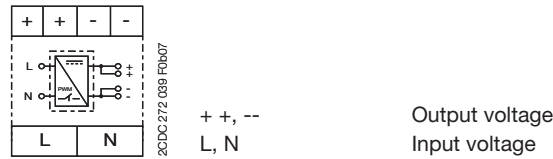

Safety instructions and warnings

The device must be installed by qualified persons only and in accordance with the specific national regulations (e. g. VDE, etc.).

CP-D power supplies are chassis-mounted units. They are maintenance-free and do not contain any integral setting elements and should therefore not be opened.

Before any installation, maintenance or modification work:

Disconnect the system from the supply network and protect against switching on!

Before start of operation the following must be ensured:

- Connect to main according to the specific national regulations.
- Power supply cables and unit must be sufficiently fused. A disconnecting device has to be provided for the end product to disengage unit and supply cables from supply mains if required.
- Rate the output lines for the output current of the power supply and connect them with the correct polarity.
- In order to ensure sufficient air-cooling the distance to the other devices has to be considered.

Attention! Improper installation/operation may impair safety and cause operational difficulties or destruction of the unit.

In operation pay attention to:

- Do not modify the installation (primary and secondary side)! High current! Risk of electric arcs and electric shock (danger to life)!
- Risk of burns: Depending on the operation conditions the enclosure can become very hot.
- If the internal fuse blows, most probably the device is defect. In this case, an examination of the switch mode power supply by the manufacturer is necessary.

Attention! Danger to life!



Disconnect the system from the supply network before executing any works at the device and protect against switching on!

The power supply contains components with high stored energy and circuits with high voltage! Do not introduce any objects into the unit and do not open the unit.

With some units of this range the output is capable of providing hazardous energy. Ensure that the service personnel is protected against inadvertent contact with parts carrying energy.

Power supply CP-D 24/4.2

Primary switch mode power supply

Data sheet

Technical data

Data at $T_a = 25\text{ °C}$, $U_{IN} = 230\text{ V AC}$ and rated values, if nothing else indicated

Input circuits - Supply circuits		1SVR 427 045 R0400	
Rated input voltage U_{IN}	L, N	100-240 V AC	
Typical current / power consumption	100-240 V AC	110 V AC	230 V AC
		1800 mA / 117.3 W	900 mA / 114.4 W
Input voltage range	AC	90-264 V AC	
	DC	120-370 V DC	
Frequency range	AC	47-63 Hz	
Inrush current		60 A max. 3 ms	
Power failure buffering time		min. 60 ms	
Internal input fuse (apparatus protection, not accessible)		3.15 A slow-acting / 250 V AC	
Indication of operational states		1SVR 427 045 R0400	
Output voltage	DC ON: green LED	┌───┐: output voltage applied	
	DC LOW: red LED	┌───┐: output voltage too low	
Operating controls		1SVR 427 045 R0400	
Potentiometer - OUTPUT Adjust: Potentiometer	OUTPUT Adjust	Output adjustment	
Output circuits		1SVR 427 045 R0400	
Rated output voltage	++,--	24 V DC	
Tolerance of the output voltage		$\pm 1\%$	
Adjustment range of the output voltage		24-28 V DC	
Rated output power		100 W	
Rated output current I_r	$T_a \leq 60\text{ °C}$	4.2 A	
Derating of the output current	$60\text{ °C} < T_a \leq 70\text{ °C}$	2.5 %/K	
Deviation	load change statical	max. 1 %	
	load change dynamical 10-90 %		
	change of input voltage within the input voltage range	max. 1 %	
Control time		< 1 ms	
Starting time after applying supply voltage	at I_r	1000 ms	
Rise time	at rated load	typ. 1 ms	
Residual ripple and switching peaks	BW = 20 MHz	50 mV	
Parallel connection		no	
Series connection		yes, to increase voltage	
Resistance to reverse feed		35 V / 1 s	
Power factor correction (PFC)		no	
Output curve		U/I curve	
Short-circuit protection		continuous short-circuit stability	
Short-circuit behaviour		continuation with output power limitation	
Current limitation at short circuit		typ. 11.5 A	
Overload protection		output power limitation	
No-load protection		continuous no-load stability	
Starting of capacitive loads		unlimited	

Power supply CP-D 24/4.2

Primary switch mode power supply

Data sheet

General data		1SVR 427 045 R0400
Duty time		100 %
Dimensions (W x H x D)		89.9 x 91 x 57.5 mm (3.54 x 3.58 x 2.26 inches)
Material of enclosure	enclosure	Plastic
Efficiency		typ. 89 %
Weight		0.32 kg (0.71 lb)
Mounting position		horizontal
Minimum distance to other units		
normal operation mode	horizontal	25 mm (0.98 inch)
	vertical	25 mm (0.98 inch)
Mounting		DIN rail (EN 60715), snap-on mounting without any tool
Degree of protection	enclosure / terminals	IP20 / IP20
Class of protection		II
Electrical connection		1SVR 427 045 R0400
Input circuit / Output circuit		Screw connection
Wire size	fine-strand with wire end ferrule	0.2-2.0 mm ² (24-14 AWG)
	fine-strand without wire end ferrule	0.2-2.0 mm ² (24-14 AWG)
	rigid	0.2-2.0 mm ² (24-14 AWG)
Stripping length		6 mm (0.24 inches)
Tightening torque		0.36-0.56 Nm
Environmental data		1SVR 427 045 R0400
Ambient temperature range	operation	-25...+70 °C
	full load	-25...+60 °C
	storage	-25...+85 °C
Damp heat, cyclic (IEC/EN 60068-2-30)		4 x 24 h cycles, 40 °C, 95 % RH
Vibration, half-sine (IEC/EN 60068-2-6)		50 m/s ² , 10 Hz - 2 kHz
Shock, half-sine (IEC/EN 60068-2-27)		40 m/s ² , 22 ms
Isolation data		1SVR 427 045 R0400
Rated isolation voltage U _i	Input circuit / Output circuit	300 V
Pollution degree		2
Standards / Directives		1SVR 427 045 R0400
Product standard		EN 61204
EMC Directive		2004/108/EC
Low Voltage Directive		2006/95/EC
Electrical safety		UL 508, UL 60950-1, EN 60950-1
Protective low voltage		SELV (EN 60950-1)

Power supply CP-D 24/4.2

Primary switch mode power supply

Data sheet

Electromagnetic compatibility		1SVR 427 045 R0400
Interference immunity		IEC/EN 61000-6-2
electrostatic discharge (ESD)	IEC/EN 61000-4-2	Level 4 (4 kV / 8 kV)
electromagnetic field (HF radiation resistance)	IEC/EN 61000-4-3	Level 3 (10 V/m)
fast transients (Burst)	IEC/EN 61000-4-4	Level 4 (4 kV)
powerful impulses (Surge)	IEC/EN 61000-4-5	Level 3 (2 kV L-L)
HF line emission	IEC/EN 61000-4-6	Level 3 (10 V)
Interference emission		IEC/EN 61000-6-3
electromagnetic field (HF radiation resistance)	IEC/CISPR 22, EN 55022	Class B
HF line emission	IEC/CISPR 22, EN 55022	Class B

Power supply CP-D 24/4.2

Primary switch mode power supply

Data sheet

Technical diagrams

Output behaviour

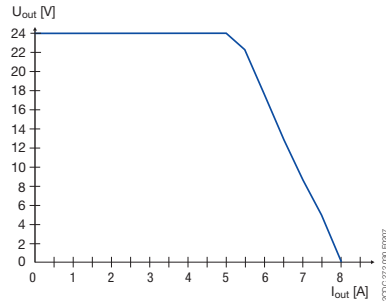

Output curve at $T_a = 25\text{ }^\circ\text{C}$

The switch mode power supply CP-D 24/4.2 is able to supply at 24 V DC output voltage and

- at an ambient temperature of:
 - ≤ 60 °C a continuous output current of approx. 4.2 A
- at ambient temperatures of:
 - 60 °C < T_a ≤ 70 °C the output power has to be reduced by 2,5 % per Celvin temperature increase.

If the switch mode power supply is loaded with an output current > 4.2 A, the operating point is passing through the U/I characteristic curve shown.

Temperature behaviour

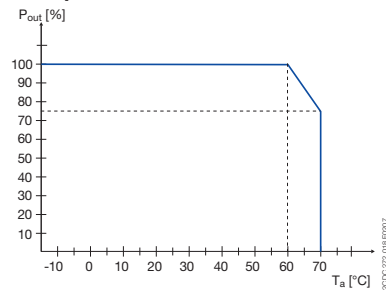

Temperature curve at U_{OUT}

Dimensions

in mm

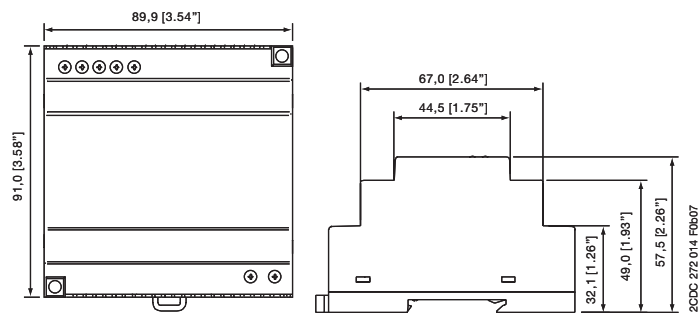

CP-D 24/4.2